



DREAMSCREEN



DREAMSCREEN

-Excelling your image-

Instruction Manual for
DreamScreen V2 WideFrame Delux DynaGrey/Brightwhite



Thank you for purchasing a DreamScreen projection screen.
Before use, please read instructions carefully. After installation, store instructions for future reference.

Description

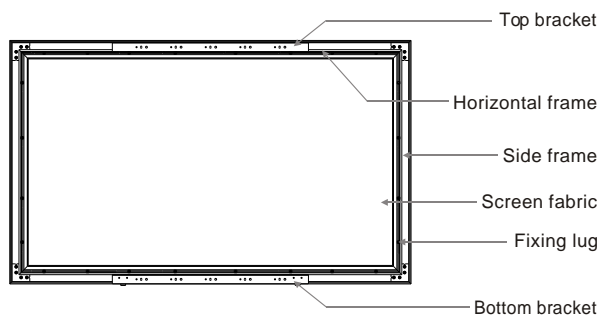

Accessories

- Horizontal frame (2pcs)



- Side frame (2pcs)



- Horizontal tensioning bar (2pcs)



- Side tensioning bar (2pcs)



- ϕ 5x40 mm Tapping screw with anchor (4pcs)



- Corner bracket (4pcs)



- 5x10mm Corner screw (16pcs)



- ϕ 5x60mm Wooden screw (4pcs)



- Top bracket(1pc)



- Bottom bracket (1pc)

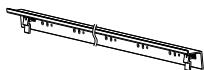

- Fixing lug (Ref. list 1)



- Instruction manual(1pc)

Fixing lug list 1

Format	Size(inch)	60"	72"	77"	80"	84"	92"	100"	106"	112"	120"	135"	150"
4:3	Qty(pcs)	20	20	24	24	24	26	28	30	30	32	34	38
16:9	Qty(pcs)	18	22	22	22	24	24	28	28	30	30	34	38

Remark: Two extra Fixing lugs for each screen

List 2 on AA distance between Top bracket and Bottom bracket (Ref. Figure 18)

Format	Size(inch)	60"	72"	77"	80"	84"	92"	100"	106"	112"	120"	135"	150"
4:3	Dist.(mm)	1025	1208	1284	1330	1391	1513	1635	1726	1818	1940	2168	2397
16:9	Dist.(mm)	858	1007	1069	1107	1156	1256	1356	1430	1505	1605	1791	1978

Warnings

- When installing, make sure it is facing forward. The back of the screen will be labeled with a sticker.
- Please read the following as any damage to the screen surface will affect the quality of the picture:
 - 1.The frame is made with lightweight aluminum. Please handle with care.
 - 2.Avoid contact or touching the screen surface as it may cause scratches or tears.
 - 3.Do not write or draw on the surface.
 - 4.Clean the screen with a soft cloth and lukewarm water. Do not use any detergent or cleaning products.
 - 5.Use a cotton cloth to carefully wipe off the dust on the frame to prevent any damages
 - 6.If it is not in use for a long period of time, cover the screen to shut out dust and dirt.
- To prevent unnecessary damage, the operating and maintenance of the screen should be done by adults.



Ignoring the safety warnings may lead to injuries and/or damaging the product.



Fixtures should be installed in a secure place to avoid accidents or the screen falling.



Please contact your local dealer for repairs or maintenance. Please contact our company if you have any further questions. Avoid taking apart the fixtures yourself. Loose parts may cause the screen to fall.

Do not take apart and replace with unknown parts. If there are any problems, please contact your local dealer. Product specifications are subject to change.

8. Uplift the assembled screen to make sure Up groove meet with Top bracket, and Down groove meet with Bottom bracket, the Secure button would lock into Groove B because of spring tension when frames are matched on brackets ideally. (Figure 21-22)

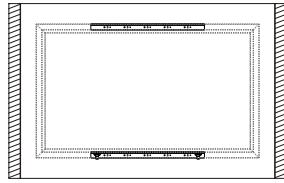

Figure 21

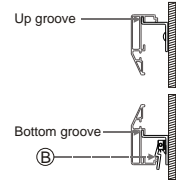

Figure 22

9. To tear down the screen, please press the Secure buttons towards wall to release bottom frame from groove B, then uplift the screen little to release it totally from up groove & bottom groove of the brackets. (Figure 23-24)

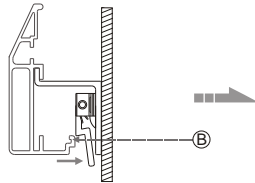

Figure 23

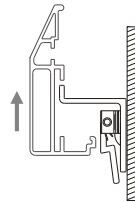

Figure 24

Installation

Take out all the parts from the packaging and follow the accessories guideline to ensure you have all parts, then install the screen as below.

1. Locate Horizontal frames and Side frames on tidy flat surface. (Figure 1)

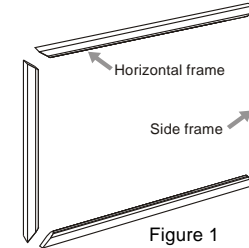

Figure 1

2. Slide Fixing lugs into grooves on reverse side of frames and align with arrows. (Figure 2-3)

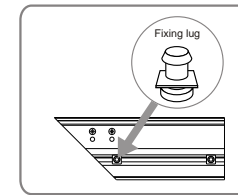

Figure 2

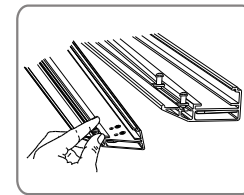

Figure 3

3. Connect Horizontal frame and Side frame with Corner bracket, adjust the Corner bracket to match screw holes on frame and Corner bracket, then fix with the Corner bracket screws. Same way to other 3 Corner brackets installation. (Figure 4-7)

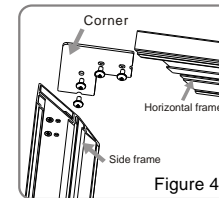

Figure 4

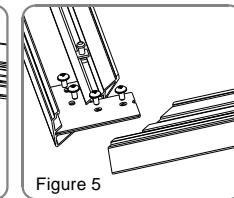

Figure 5

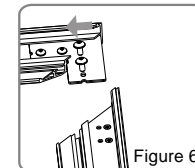

Figure 6

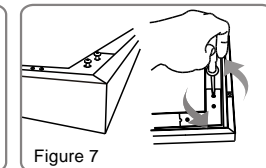

Figure 7

4. Unfold screen fabric and insert 4 Tensioning bars separately into 4 different fabric grooves, be careful not to poke the fabric. (Figure 8-10)

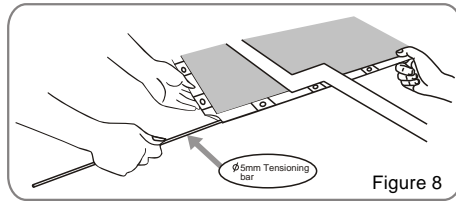

Figure 8

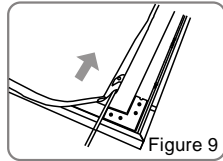

Figure 9

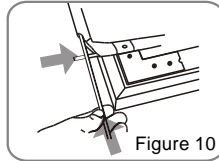

Figure 10

5. Double align Fixing lugs with arrows. Using the Tensioning bar, pull fabric eyelets over Fixing lugs by your hands clockwise (Tips: arrange Horizontal tensioning bars first then Side tensioning bars). (Figure 11-15)

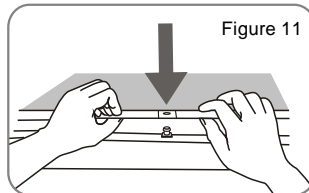

Figure 11

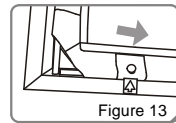

Figure 13

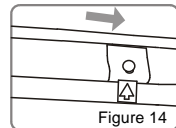

Figure 14

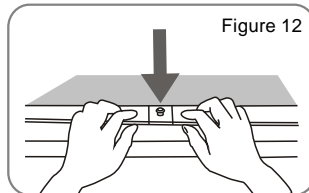

Figure 12

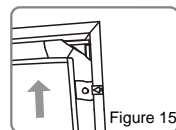

Figure 15

6. There is locking system on the Bottom bracket but no on the Top bracket, brackets' length are at half of Horizontal frames'. And there is 5 groups of holes on each brackets with 10cm distance, each group has 3 holes at $\varnothing 5$ $\varnothing 8$ & $\varnothing 6$ from left to right. Brackets are suggested to mount at the middle point of frame with only 30% fluctuation if needed. (Figure 16)

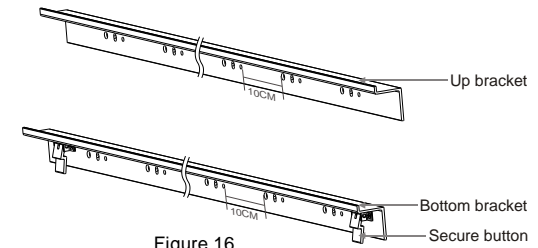

Figure 16

7. According to AA distance list on first page, mount two brackets onto the wall separately, assure they are at horizontal level. (Figure 17-18)

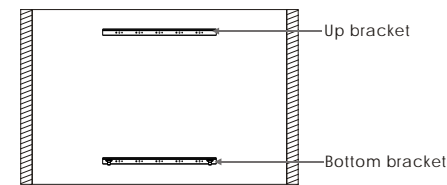

Figure 17

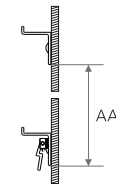

Figure 18

Here below are the mounting details:

- Wood wall mounting: to fix the brackets onto the wall using 4 provided Wooden screws $\varnothing 5 \times 60$, two screws for each bracket. (Figure 19)
- Concrete wall mounting: to use an electric drill to drill 4 holes (2 holes for each bracket), and hammer the provided tapping anchors into each hole, then fix the brackets onto the wall by fastening the tapping screws to the tapping anchors. (Figure 20)

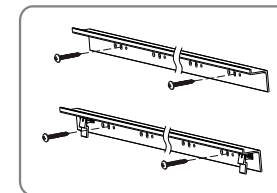

Figure 19

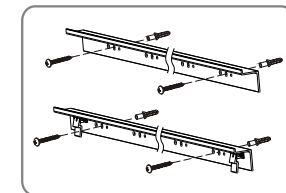

Figure 20