

DREAMSCREEN

DREAMSCREEN

-Excelling your image-

Installation Guide for
Manual Pull-Down with Speed Control Mechanism

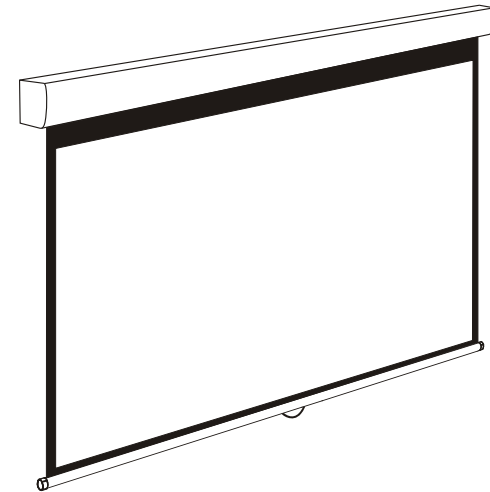

Thank you for purchasing a DreamScreen projection screen.
Before use, please read instructions carefully. After installation, store instructions for future reference.

Description

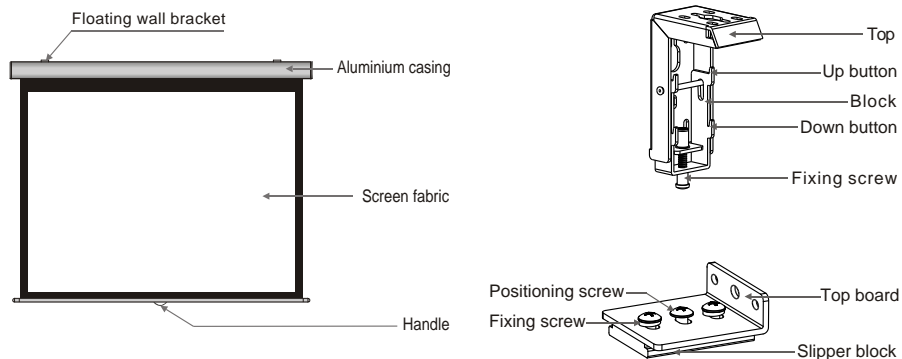

Accessories

- Floating wall bracket(2pcs)
- $\phi 5 \times 40$ mm Tapping screw & cap (8sets)
- Spring Washer (4pcs)



- M6x10 Screw (6pcs)



- Instruction manual (1pc)

- Top Board (2pcs)



Warnings

- The ceiling or wall used for fixture installation must be secure to prevent the screen from falling down.
- Make sure the Fixing screw be fastened when using the wall bracket, to avoid any damage.
- Please read the following as any damage to the screen surface will impact the image's quality:
 1. Do not touch the screen surface by hand.
 2. Do not write or draw on the screen surface.
 3. Do not poke the screen surface by finger or edge tools, as it may cause scratches or tears.
 4. Do not use any detergent or cleaning products to clean the screen surface, please clean it with a soft cloth and lukewarm water.
- Retract the screen after every use.
- Ensure the screen is level when it is wall-mounted installation, when the screen is spread, it should be balanceable with the wall.
- Do not pull two sides of the screen fabric by hands, do not fold the screen fabric.
- To prevent unnecessary damage, the operation and maintenance of the screen should be done by adult.



Ignoring the safety warnings may lead to injuries or damaging the product.



The screen should be installed at secure place to avoid any accidents or the screen falling down.



Retract the screen after every use. Leave it hanging for a long period may cause screen fabric loose



Please contact your local dealer for repair or maintenance, and contact us if you have any further questions. Avoid taking apart the fixtures by yourself. Loose parts may cause the screen fall down.



Avoid hanging anything on the screen as it may cause the screen to fall down.

Do not take apart and replace with unknown parts. If there are any problems, please contact your local dealer. Product specifications are subject to change.

Instructions

Pull down to the desired height; pause for 3 seconds, and the screen will self-lock.

1. Use rope to pull down bottom rod until within hand reach distance.
2. Continue to pull down with hand to desired height, and then hold for 3 seconds.
3. To retract screen, pull down lightly to release locking system, let go and the screen will return to casing.

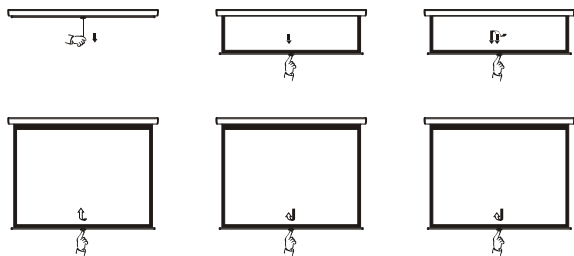

Installation

Take out all the parts from the packaging and follow the accessories guideline to ensure you have all parts.

There are three installation measures for this product, namely wall mounting, ceiling mounting and ceiling hang. The installed distance can be changeable up to your needs via adjusting the slipper block, while the ideal position is the mounting bracket is at its nearest point to the endcap, which can reduce unnecessary vibration or noise.

Floating wall bracket installation

1. Choose screws for mounting according to wall material. (Tips: Wood screws for wood wall, and Tapping screws for concrete wall.)
2. Mount the brackets onto the wall, assuring they are at the horizontal level. (Tips: draw an erasable level line when mounting the brackets) (Figure 1) Here below are the details:

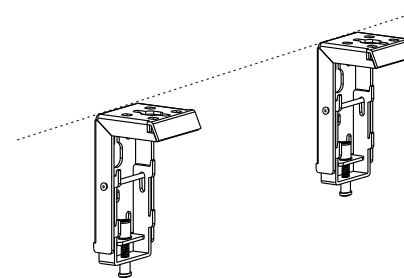

Figure 1

Installation Steps

- a) Wood wall and ceiling installation: Drill in the $\phi 5 \times 60$ screws through the appropriate holes in the bracket (Figure 2-3).
- b) Drywall and ceiling and installation: Install the anchors and drill in the $\phi 5 \times 40$ screws into the appropriate bracket holes. (Figure 4-5).

Wood wall installation

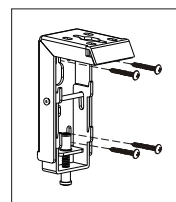

Figure 2

Wood ceiling installation

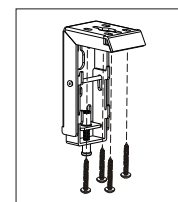

Figure 3

Concrete wall installation

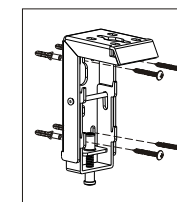

Figure 4

Concrete ceiling installation

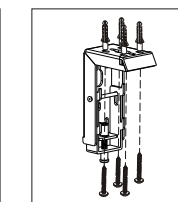
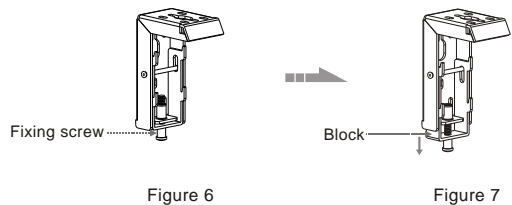
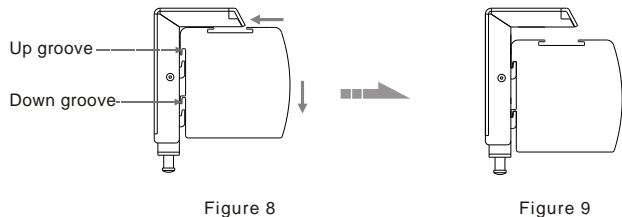

Figure 5

3. Loose the Fixing screw to lower down the Block all the way. (Figure 6-7)



4. When mounting the screen onto Floating wall brackets, make sure the Up groove and the Down groove on the housing match with the Up button and the Down button on the bracket separately. (Figure 8-9).



5. Fasten the Fixing screw on the bracket, to fix housing tightly onto the brackets.(Figure 10-11)

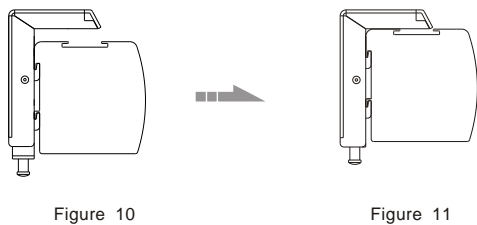

Floating hanging bracket installation

To choose the tapping screws with hanger or other screws with hanger (unprovided) according to ceiling material. (Tips: Wood screws $\phi 5 \times 60$ for wook ceiling and tapping screws for concrete wall.)

1. To drill two same holes with an electric drill horizontally with wall, then fasten hangers(unprovided) onto the ceiling. (Figure 12)

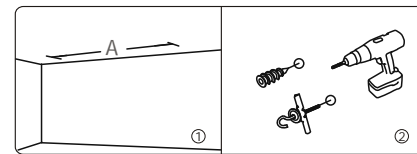

Figure 12

2. Use M6x10 Screws in the accessory package to fix the Top Boards on the Sliding Blocks which are on the groove on top of the screen, and make sure the Tightening Screws on both sides are fixed tightly, but temporarily not to fix tightly the Positioning Screws in the middle of Top Boards. (Note: please add washers in the Tightening Screws on both sides of Top Boards) (Figure13-14)

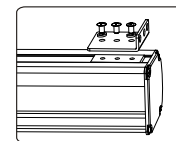

Figure 13

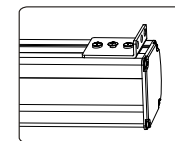

Figure 14

3. After hanging the casing onto pothook (Note: pothook shall be hung onto the middle holes of Top Boards), please check whether the casing is acclivitous, if it is, please unscrew the Tightening Screws and adjust the Top Boards to make the casing balanceable, and then fix tightly the Tightening Screws and Positioning Screws, to make sure the casing is fixed at suitable position (Figure15-16), and check the security of the pothook and make reasonable action to avoid any possibility of the Top Boards sliding down accidentally.

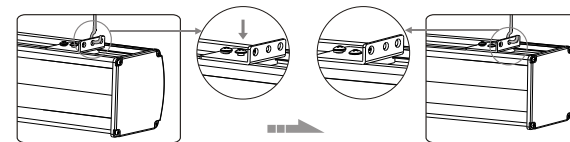

Figure 15

Figure 16